

HelloDevice Lite Series

LS100

User Guide

Version 1.2.0

2004-05-21

User Guide for the HelloDevice LS100

Version 1.2.0

Firmware version 1.2.X

Last revised on May 21, 2004

Printed in Korea

Copyright

Copyright 2002, Sena Technologies, Inc. All rights reserved.

Sena Technologies reserves the right to make changes and improvements to its product without providing notice.

Trademark

HelloDevice™ is a trademark of Sena Technologies, Inc.

Windows® is a registered trademark of Microsoft Corporation.

Ethernet® is a registered trademark of XEROX Corporation.

Notice to Users

When a system failure may cause serious consequences, protecting life and property against such consequences with a backup system or safety device is essential. The user agrees that protection against consequences resulting from system failure is the user's responsibility.

This device is not approved for life -support or medical systems.

Changes or modifications to this device not explicitly approved by Sena Technologies will void the user's authority to operate this device.

Technical Support

Sena Technologies, Inc.

210 Yangjae-dong, Seocho-gu

Seoul 137 -130, Korea

Tel: (+82-2) 573-5422

Fax: (+82-2) 573-7710

E-Mail: support@sena.com

Website: <http://www.sena.com>

Contents

1: Introduction	5
1.1 Overview	5
1.2 Package Check List	6
1.3 Product Specification	7
1.4 Terminologies and Acronyms	8
2: Getting Started	10
2.1 Panel Layout.....	10
2.2 Connecting the Hardware.....	12
2.2.1 Connecting the Power	12
2.2.2 Connecting to the Network.....	12
2.2.3 Connecting to the Device	13
2.3. Accessing Console Port.....	14
2.3.1 Using Serial Console.....	14
2.3.2 Using Remote Console.....	16
2.4 Command Usage.....	17
2.4.1 'set' Command.....	18
2.4.2 'get' Command	19
2.4.3 'help' Command.....	20
2.4.4 'factorydefault' Command	21
2.4.5 'save' Command	22
2.4.6 'exit' Command.....	22
2.4.7 'reboot' Command.....	22
3: IP Address Configuration	23
3.1 Static IP	24
3.1.1 Overview	24
3.1.2 Static IP Configuration	24
3.2 DHCP.....	25
3.2.1 Overview	25
3.2.2 DHCP Configuration	26
3.3 PPPoE	26
3.3.1 Overview	26
3.3.2 PPPoE Configuration	26
4. Host Mode Configuration	27
4.1 TCP Server Mode Operations	29
4.1.1 Overview	29
4.1.2 TCP Server Mode Configuration.....	31

4.2 TCP Client Mode Operations	32
4.2.1 Overview	32
4.2.2 TCP Client Mode Configuration	33
4.3 TCP Server/Client Mode Operations.....	34
4.3.1 Overview	34
4.3.2 TCP Server/Client Mode Configuration	35
5: Serial Port Configuration	37
6: System Administration	40
Appendix A: Connections	41
A.1 Ethernet Pin outs	41
A.2 Serial Port Pin Outs	41
A.3 Ethernet Wiring Diagram	42
A.4 Serial Wiring Diagram	42
Appendix B: Well-known Port Numbers	43
Appendix C: Troubleshooting	44
C.1 Power/LED Status Troubleshooting	44
C.2 Serial Console Troubleshooting	44
C.3 Remote Console Troubleshooting	44
C.4 IP Address Troubleshooting.....	45
C.5 DHCP Troubleshooting	45
C.6 TCP Server Mode Operation Troubleshooting	45
C.7 Serial Communication Troubleshooting.....	46

1: Introduction

1.1 Overview

The HelloDevice Lite Series allows you to network-enable a variety of serial devices that were not originally designed to be networked. This capability brings the advantages of remote management and data accessibility to thousands of serial devices over the network.

The LS100 is a most cost effective one port serial-Ethernet communication device. The LS100 supports RS232 serial communication allowing virtually any asynchronous serial device to be accessed over a network.

As for the Internet connectivity, the LS100 supports open network protocols such as TCP/IP allowing serial devices to be accessed over broadband network or conventional LAN (Local Area Network) environment.

The LS100 provides the management console using Telnet and serial console port under the password protection support. And the LS100 also provides the management function using the HelloDevice Manager Software Utility.

The LS100 was designed to accommodate the unique requirements of the Retail POS, Security, Automation and Medical marketplaces.

Parts of this manual assume the knowledge on concepts of the Internetworking protocols and serial communications. If you are not familiar with these concepts, please refer to the standards or the documentation on each subject.

1.2 Package Check List

- LS100 external box
- 110V or 230V Power supply adapter
- Serial console/data cable
- A hardcopy of Quick Start Guide
- CD-ROM including the HelloDevice Manager and User Guide

1.3 Product Specification

Serial Interface	One male DB9 serial port for data communication/serial console
	Serial speeds 1200bps to 115200bps
	Flow Control: None, Hardware RTS/CTS
	Signals: Rx, Tx, RTS, CTS, DTR, DSR, GND
Network Interfaces	10 Base-T Ethernet with RJ45 Ethernet connector
	Supports static and dynamic IP address
Protocols	ARP, IP/ICMP, TCP, Telnet, DHCP client, PPPoE
Security	User ID & Password
Management	Telnet or serial console port or HelloDevice Manager
Diagnostic LED	Full-featured system status display
	Power
	Ready
	10 Base-T Link, Act Serial Rx/Tx for data serial port
Power	Supply voltage 7.5V ~ 15V DC
	Supply current 140mA (nom.)
Environmental	Operating temperature: 0 ~ 55 °C
	Storage temperature: -4 ~ 66 °C
Physical properties	Dimension 100 mm L (3.9 in.) 72 mm W (2.8 in.) 29 mm H (1 in.)
	Weight 230g
Approvals	FCC(A), CE(A), MIC
Warranty	5-year limited warranty

1.4 Terminologies and Acronyms

The Internetworking related terminologies used frequently in this manual are defined clearly to help your better understanding of the LS100.

MAC address

On a local area network or other network, the MAC (Media Access Control) address is the computer's unique hardware number. (On an Ethernet LAN, it's the same as your Ethernet address.)

It is a unique 12-digit hardware number, which is composed of 6-digit OUI (Organization Unique Identifier) number and 6-digit hardware identifier number. The LS100 has the MAC address of 00-01-95-xx-xx-xx, which is labeled on the bottom side of the external box.

Host

A user's computer connected to the network

In Internet protocol specifications, the term "host" means any computer that has full two-way access to other computers on the Internet. A host has a specific "local or host number" that, together with the network number, forms its unique IP address.

Session

A series of interactions between two communication end points that occur during the span of a single connection

Typically, one end point requests a connection with another specified end point and if that end point replies agreeing to the connection, the end points take turns exchanging commands and data ("talking to each other"). The session begins when the connection is established at both ends and terminates when the connection is ended.

Client/Server

Client/server describes the relationship between two computer programs in which one program, the client, makes a service request from another program, the server, which fulfills the request.

A server is a computer program that provides services to other computer programs in the same or other computers, whereas a client is the requesting program or user in a client/server relationship. For example, the user of a Web browser is effectively making client requests for pages from servers all over the Web. The browser itself is a client in its relationship with the computer that is getting and returning the requested HTML file. The computer handling the request and sending back the HTML file is a server.

Table 1-1 Acronym Table

ISP	Internet Service Provider
PC	Personal Computer
NIC	Network Interface Card
MAC	Media Access Control
LAN	Local Area Network
UTP	Unshielded Twisted Pair
ADSL	Asymmetric Digital Subscriber Line
ARP	Address Resolution Protocol
IP	Internet Protocol
ICMP	Internet Control Message Protocol
UDP	User Datagram Protocol
TCP	Transmission Control Protocol
DHCP	Dynamic Host Configuration Protocol
SMTP	Simple Mail Transfer Protocol
FTP	File Transfer Protocol
PPP	Point-To-Point Protocol
PPPoE	Point-To-Point Protocol over Ethernet
HTTP	HyperText Transfer Protocol
DNS	Domain Name Service
SNMP	Simple Network Management Protocol
UART	Universal Asynchronous Receiver/Transmitter
Bps	Bits per second (baud rate)
DCE	Data Communications Equipment
DTE	Data Terminal Equipment
CTS	Clear to Send
DSR	Data Set Ready
DTR	Data Terminal Ready
RTS	Request To Send

2: Getting Started

This chapter describes how to set up and configure the LS100 in the first place.

- 2.1 *Panel Layout* explains the panel layout and LED indicators.
- 2.2 *Connecting the Hardware* describes how to connect the power, the network, and the serial device to the LS100.
- 2.3 *Accessing Console Port* describes how to access the console port using a serial console at a local site or telnet console at a remote site.
- 2.4 *Command Usages* described how to use command set of the LS100 to configure and view parameter values and status.

Following items are pre-required to get started.

- One DC power adapter (included in the package).
- One serialconsole cable for configuration (included in the package).
- One RS-232 serial cable for connecting the RS-232 serial device.
- One PC with Network Interface Card (hereafter, NIC) and/or one RS232 serial port.
- Terminal emulation program running on the PC
- One Ethernet cable

2.1 Panel Layout

The LS100 has five LED indicator lamps for status display. Two lamps on the upper side indicate statuses of 10 Base-T Ethernet Link and Act. Next lamp indicates statuses of receive and transmit of the serial port for data communication. Next two lamps indicate the system running status and the system power-on status. Table 2-1 describes function of each LED indicator lamp.

Table 2-1. LED indicator lamps

Lamps		Function
10 Base-T	Link	Turned on to Green if connected to 10 Base-T Ethernet network
	Act	Blink whenever there is any activities such as incoming or outgoing packets through the LS100 Ethernet port
Serial port	Rx/Tx	Blink whenever there is any incoming or outgoing data stream through the serial port of the LS100
Status	Ready	Turned on to GREEN if system is running.
	Power	Turned on to RED if power is supplied

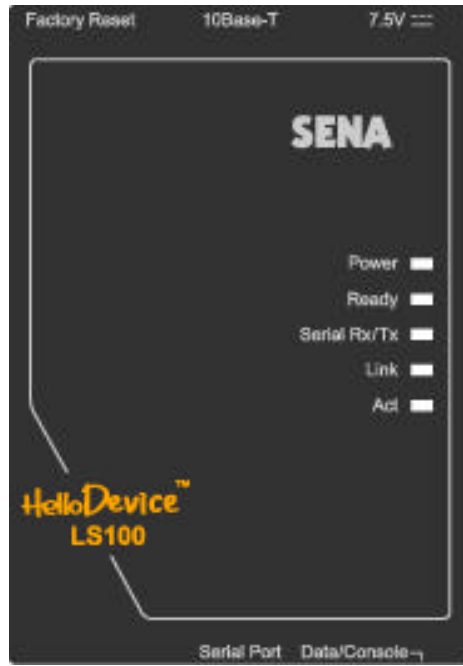

Figure 2-1. The panel layout of the LS100

2.2 Connecting the Hardware

This section describes how to connect the LS100 to serial device for the first time test.

- Connect the power to the LS100
- Connect the Ethernet cable between the LS100 and Ethernet hub or switch
- Connect the serial data cable between the LS100 and a serial device

2.2.1 Connecting the Power

Connect the power jack to the LS100 power jack using DC power adapter included in the package. If the power is properly supplied, the [Power] lamp of the LS100 will maintain solid red.

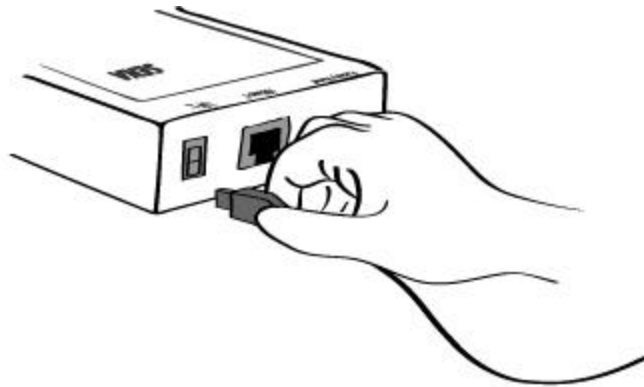

Figure 2-2. Connecting the power to the LS100

2.2.2 Connecting to the Network

Connect the one end of the Ethernet cable to the LS100 10Base-T port and the other to the Ethernet network. If the cable is properly hooked up, the LS100 will have a valid connection to the Ethernet network by indicating:

- [Link] lamp of the LS100 maintains solid green
- [Act] lamp continuously blinks to indicate the incoming/outgoing Ethernet packets

If any of the above does not happen, the LS100 is not properly connected to the Ethernet network.

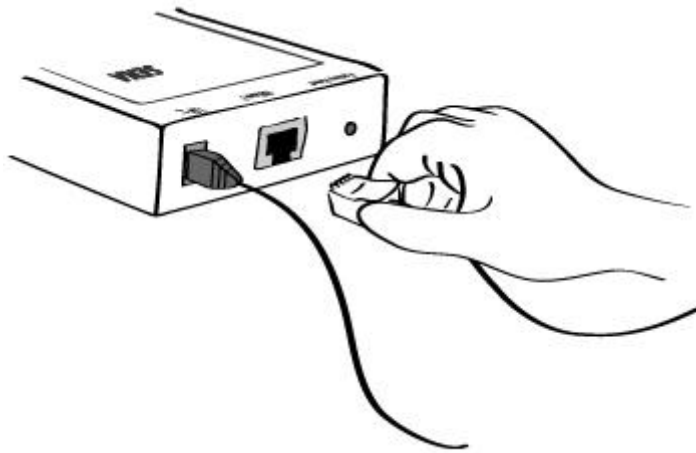

Figure 2-3. Connecting a network cable to the LS100

2.2.3 Connecting to the Device

Connect the serial data cable between the LS100 and the serial device. If necessary, supply the power to the serial device attached to the LS100.

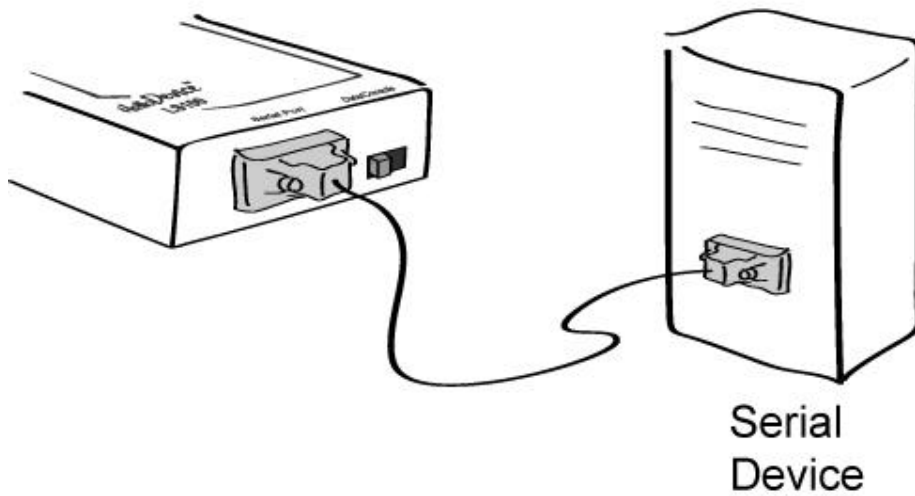

Figure 2-4. Connecting a serial device to the LS100

2.3. Accessing Console Port

There are two ways to access console port of the LS100 depending on whether the user is located at a local site or a remote site.

- Serial console:

Local users can connect directly to the serial console port of the LS100 using serial console/data cable (null-modem cable). The serial port of the LS100 is used as the console port as well as the data port. To use the serial port as the console port, slide Data/Console switch to the Console side.

- Remote console:

Remote users can make a telnet connection to the remote console port (port 23) of the LS 100 via TCP/IP network.

Both methods require the user to log into the LS100 in order to continue.

2.3.1 Using Serial Console

- 1) Connect the one end of the serial console cable to the serial port of the LS100.

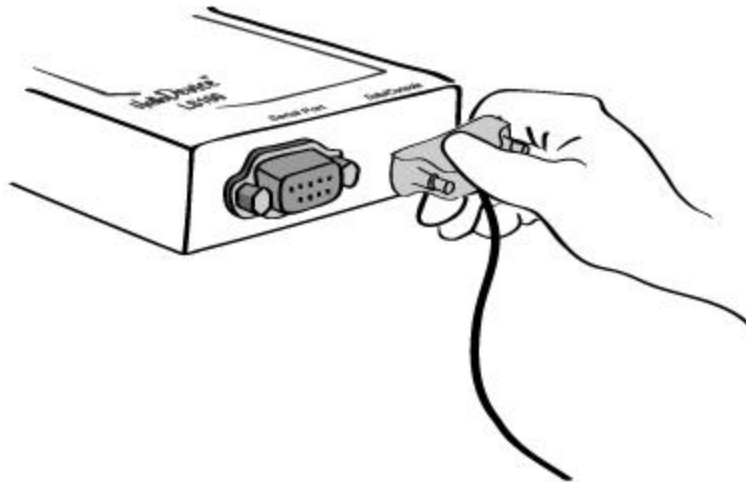

Figure 2-5. Connecting a serial console cable to the LS100

- 2) Connect the other end of the cable to the serial port of user's computer.
- 3) Slide Data/Console switch to Console side.

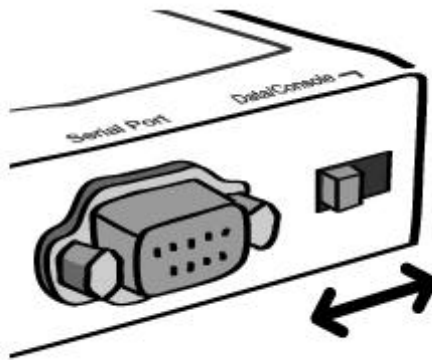

Figure 2-6. Data/Console switch of the LS100

- 4) Run a terminal emulator program such as HyperTerminal. Set up the serial configuration parameters of the terminal emulation program as follows:
9600 Baud rate, Data bits 8, Parity None, Stop bits 1, No flow control
- 5) Press [ENTER] key.
- 6) Type the user name and password to log into the LS100. A factory default setting of the user name and password are both **admin**.
- 7) If the user logged into the LS100 successfully, command prompt screen will appear on the computer as shown in Figure 2-7.

```
login: admin
password: *****
Type 'help' to get command usages
> help
set group par1 [par2 ...] + <CR>
- group = 'ip','host','serial' or 'admin'
- par1 ... = configuration parameters. Use * to keep a parameter's value
get [group] + <CR>
- group = 'ip','host','serial','admin' or 'status'
- If group is specified, shows settings of the group.
- If group is omitted, shows settings of all groups.
factorydefault [option] + <CR>
- if option is omitted, all parameters are set with factory default values.
- if option='-ip',
  all parameters except IP settings are set with factory default values.
help [group] + <CR>
- If group is omitted, shows this screen.
- If group is specified, shows 'set' command usage of the group.
save + <CR>
- Save changes
exit + <CR>
- Exit without rebooting the device
reboot + <CR>
- Exit and reboot the device
>
```

Figure 2-7. The LS 100 console screen

From the command prompt screen, users can set, get and save configuration parameter values using 'set', 'get' and 'save' command. Users also can exit the console or reboot the device using 'exit' and 'reboot' command. The usage of the commands can be found using 'help' command. For command usages description, please refer to section 2.4 *Command usage*.

2.3.2 Using Remote Console

The LS100 provides remote console feature via telnet as well as serial console so that users can access the LS100 at remote site for configuration and monitoring purpose. The IP address of the LS100 must be known before users can access the remote console port. The port number for the remote console is 23, which is a TCP port number assigned for Telnet.

Only one user can log into the remote console or serial console at a time. If the serial console is established while a remote console is established, current remote console will be halted and no more remote console will be established until serial console is finished.

To access remote console of the LS100, please use the step as follows:

- 1) Run a telnet program or a program that supports telnet functions such as TeraTerm-Pro or HyperTerminal. The target IP address and the port number should be those of the LS100. If required, specify the port number as 23. Type the following command in the command line interface of your computer.

```
telnet 192.168.1.254
```

Or run a telnet program with parameters as follows.

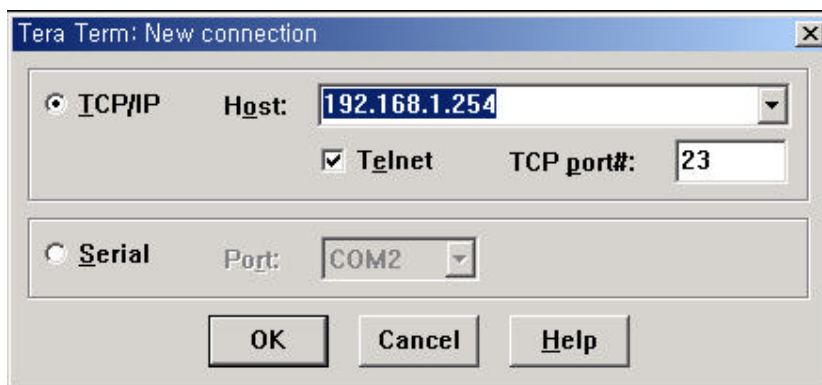

Figure 2-8 Telnet program set up example

- 2) The user has to log into the LS100. Type the user name and password. A factory default setting of the user name and password are both **admin**.
- 3) If the user logged into the LS100 successfully, the same command prompt screen as the one

of serial console will be displayed. The user can set, get, save configuration parameters and exit console, reboot the device as like the serial console.

- 4) If serial console or the other remote consoles are connected already, new console will not be established at all.

2.4 Command Usage

The LS100 provides several simple commands for configuration and control of the LS100. Table 2-2 summarizes command set which LS100 supports.

Table 2-2 LS100 command set summary

Command	Description	Result
set group par1 [par2 ...] + <CR>	Set configuration parameters - group = 'ip', 'host', 'serial' or 'admin' - par1 ... = configuration parameters. Use * to keep a parameter's value	If success, "OK" + <CR> + <LF> If error "ERROR" + <CR> + <LF>
get [group] + <CR>	Get configuration parameter values - group = 'ip', 'host', 'serial', 'admin' or 'status' - If group is specified, shows settings of the group. - If group is omitted, shows settings of all groups.	Parameter value display
help [group] + <CR>	Shows command usage screen. - If group is omitted, shows help screen. - If group is specified, shows 'set' command usage of the group.	Help message display
factorydefault [option] + <CR>	Restore factory default values - if option is omitted, all parameters are set with factory default values. - if option='-ip', all parameters except IP settings are set with factory default values.	If success, "OK" + <CR> + <LF> If error "ERROR" + <CR> + <LF>
save + <CR>	Save changes	If success, "OK" + <CR> + <LF> If error "ERROR" + <CR> + <LF>
exit + <CR>	Exit without rebooting the device (changes are not applied)	If success, "OK" + <CR> + <LF> If error "ERROR" + <CR> + <LF>
reboot + <CR>	Exit and reboot the device	None

2.4.1 'set' Command

With 'set' command, users can configure parameter values of the LS100 for each environment. Basic 'set' command usage is as follows:

set group par1 [par2 ...] + <CR>

where,

group = 'ip', 'host', 'serial' or 'admin'

par1 par2 ... = configuration parameters. Use * to keep a parameter's value

The 'group' is the category where the parameters should be entered. For example, if users want to set parameters related to the IP configuration, use set command as shown in the Figure 2-9.

```
> set ip static 192.168.1.100 255.255.255.0 192.168.1.1
OK
>
```

Figure 2-9 IP configuration example screen

In the above example, the first parameter 'ip' indicates that the following parameters are IP configuration parameters. The second parameter 'static' indicates that the LS100 will use static IP address of the third parameter '192.168.1.100'. The fifth parameter indicates the subnet mask and the next indicates the default gateway IP address.

If users want to change only one of the parameters of the group, users can omit trailing parameters and/or can use '*' to keep a parameter value. The screen below will show how to change subnet mask only without changing IP address and gateway IP address.

```
> set ip static * 255.255.0.0
OK
>
```

Figure 2-10 Changing only one parameter value example

Command usage of 'set' will differ depending on the groups. Each 'set' command usage of the group can be found using 'help group' command. For example, if users want to know how to use 'set' command to configure IP configuration, typing 'help ip' + <CR> will show 'set' command usage for the IP configuration as shown in Figure 2-11.

```
> help ip
set ip ipmode par1 par2 ...
- ipmode: static=Static IP / dhcp=DHCP / pppoe=PPPoE
- parameters:
if ipmode = static,
    par1 = IP address,
    par2 = subnet mask,
    par3 = gateway
```

```
if ipmode = dhcp,  
    no parameters required  
if ipmode = pppoe,  
    par1 = PPPoE username,  
    par2 = PPPoE password  
>
```

Figure 2-11 Help screen example

Note:

The changed values will not take effect until 'save' and 'reboot' commands are invoked. For more details, please refer to section 2.4.5 ~ 2.4.7.

2.4.2 'get' Command

With 'get' command, users can view the current parameter values and status of the LS100. Basic 'get' command usage is as follows:

get [group] + <CR>

where,

group = 'ip', 'host', 'serial', 'admin' or 'status'

- If group is specified, shows settings of the group.

- If group is omitted, shows settings of all groups.

The group means the category where parameters belong to as like 'set' command. For example, if users want to view parameter values related to IP configuration, get command as Figure 2-12 can be used.

```
> get ip  
IP_mode: static  
IP_address: 192.168.1.100  
Subnet_mask: 255.255.255.0  
Gateway: 192.168.1.1  
>
```

Figure 2-12 Getting ip configuration screen

'status' group is a special group where 'set' command does not apply. 'get status' will show current system status screen.

```
> get status  
Serial_no.: LS100-0207_test  
MAC_address: 00-01-95-77-88-99  
F/W_REV.: V1.2.0  
Current_IP: 192.168.0.125  
>
```

Figure 2-13 Getting status screen

If group is omitted, get command will show all of the parameter values as shown in Figure 2-14.

```
> get
--- Status ---
Serial_no.: LS100-0207_test
MAC_address: 00-01-95-77-88-99
F/W_REV.: V1.2.0
Current_IP: 192.168.0.125
--- Admin ---
Username: admin
Password: admin
Devicename: LS100 Device
--- IP ---
IP_mode: dhcp
--- Host ---
Host_mode: tcps
Local_port: 6001
Inactivity_timeout(sec): 300
--- Serial ---
Baudrate: 9600
Data_bits: 8_bits
Parity: None
Stop_bits: 1_bit
Flow_control: None
DTR_option: Always_high
DSR_option: None
Interchar_timeout(ms): 50
>
```

Figure 2-14 Getting all parameters screen

2.4.3 'help' Command

With 'help' command, users can find command usage help in the console screen. Basic command usage is as follows:

help [group] + <CR>

where,

if group is omitted, overall help screen will be displayed

if group is specified, 'set' command usage of specified group will be displayed.

Figure 2-15 shows help screen when no group is specified while Figure 2-16 shows help screen with 'ip' group specified.

```
> help
set group par1 [par2 ...] + <CR>
- group = 'ip','host','serial' or 'admin'
- par1 ... = configuration parameters. Use * to keep a parameter's value
get [group] + <CR>
- group = 'ip','host','serial','admin' or 'status'
- If group is specified, shows settings of the group.
- If group is omitted, shows settings of all groups.
help [group] + <CR>
```

```

- If group is omitted, shows this screen.
- If group is specified, shows 'set' command usage of the group.
factorydefault [option] + <CR>
- if option is omitted, all parameters are set with factory default values.
- if option='-ip',
    all parameters except IP settings are set with factory default values.
save + <CR>
- Save changes
exit + <CR>
- Exit without rebooting the device
reboot + <CR>
- Exit and reboot the device

```

Figure 2-15 Help screen

```

> help ip
set ip ipmode par1 par2 ...
- ipmode: static=Static IP / dhcp=DHCP / pppoe=PPPoE
- parameters:
if ipmode = static,
    par1 = IP address,
    par2 = subnet mask,
    par3 = gateway
if ipmode = dhcp,
    no parameters required
if ipmode = pppoe,
    par1 = PPPoE username,
    par2 = PPPoE password

```

Figure 2-16 Help screen with 'ip' group specified

2.4.4 'factorydefault' Command

With 'factorydefault' command, users can load factory default parameter values in console. Command usage of 'factorydefault' is as follows:

factorydefault [option] + <CR>

where,

- if option is omitted, all parameters are set with factory default values.
- if option='-ip', all parameters except IP settings are set with factory default values.

Loaded values are not saved until 'save' command invoked. After 'factorydefault' command, 'save' and 'reboot' commands are required for changes to take effect.

```

> factorydefault (or factorydefault -ip)
OK
> save
OK
> reboot

```

Figure 2-17 Factory default reset screen

2.4.5 'save' Command

With 'save' command, current parameter changes are saved to non-volatile memory. Command usage of 'save' command is as follows:

save + <CR>

Saved changes will be applied if the LS100 is rebooted by 'reboot' command or manual rebooting.

2.4.6 'exit' Command

With 'exit' command, current serial or remote console session will be closed. However, changed parameters are not applied until the LS100 is manually rebooted. Command usage of 'exit' command is as follows:

exit + <CR>

2.4.7 'reboot' Command

With 'reboot' command, the LS100 will be rebooted immediately. Changed parameter values will be applied when the LS100 is up again. Command usage of 'reboot' is as follows:

reboot + <CR>

3: IP Address Configuration

A valid IP address of the LS100 needs to be assigned before it starts to work in the user's network environment. A network system administrator may provide the user with this IP address setting information for the network. The IP address must be unique within the network. Otherwise, the LS100 will not have a valid connection to the network.

Users can choose the desired IP mode out of the three IP operating modes, i.e., **Static IP**, **DHCP** and **PPPoE**. The factory default IP mode is **DHCP** mode. Table 3-1 shows the parameter items for IP configuration.

Table 3-1 IP configuration parameters

Static IP	IP address
	Subnet mask
	Default gateway
DHCP	No parameters required
PPPoE	PPPoE username
	PPPoE password

Basic 'set' command usage for IP configuration is as follows:

set ip ipmode par1 par2 ...

where,

ipmode: 'static' for Static IP / 'dhcp' for DHCP / 'pppoe' for PPPoE

parameters:

if ipmode = static,

par1 = IP address, par2 = subnet mask, par3 = gateway

if ipmode = dhcp,

no parameters required

if ipmode = pppoe,

par1 = PPPoE username, par2 = PPPoE password

3.1 Static IP

3.1.1 Overview

In the **Static IP** mode, users have to manually specify all the parameters such as **IP addresses** of the LS100, valid **subnet mask** and the **default gateway** IP address.

IP address is an identification number assigned to a computer as a permanent address on the network. Computers use IP addresses to identify and talk to each other on the network. Choose the proper IP address which is unique and valid on the network environment.

A subnet represents all the network hosts at one geographic location, in one building, or on the same local area network. When there is any outgoing packet over the network, the LS100 will check whether the desired TCP/IP host specified in the packet is on the local network segment with the help of the **subnet mask**. If the address is proven to be on the same network segment as the LS100, the connection is established directly from the LS100. Otherwise, the connection is established through the given default gateway.

A **gateway** is a network point that acts as an entrance to another network. Usually, the computers that control traffic within the network or at the local Internet service provider are gateway nodes. The LS100 needs to know the IP address of the default gateway computer in order to communicate with the hosts outside the local network environment. For correct information on the gateway IP address, please refer to the network administrator.

3.1.2 Static IP Configuration

To configure IP configuration parameters of the LS100, use set command as follows:

```
set ip static ip_address subnet_mask default_gateway + <CR>
```

where,

ip_address = IP address of the LS100

subnet_mask = Subnet mask

default_gateway = Default gateway IP address

Figure 3-1 shows IP configuration command example screen. To apply changes, users have to invoke 'save' and 'reboot' command after changing configuration.

```
> set ip static 192.168.1.10 255.255.255.0 192.168.1.1  
OK
```

Figure 3-1. Setting IP configuration parameters for Static IP mode

3.2 DHCP

3.2.1 Overview

Dynamic Host Configuration Protocol (DHCP) is a communications protocol that lets network administrators manage and automate the assignment of IP addresses centrally in an organization's network. DHCP lets a network administrator supervise and distribute IP addresses from a central point and automatically send a new IP address when a computer is plugged into a different place in the network.

As described in the section 3.1, the IP address must be entered manually at each computer in Static IP mode and, if computers move to another location in another part of the network, a new IP address must be entered. Meanwhile, all the parameters including the IP address, subnet mask, gateway, DNS servers will be automatically configured when the IP address is assigned in DHCP mode. DHCP uses the concept of a "lease" or amount of time for which a given IP address will be valid for a computer. All the parameters required to assign an IP address are configured on DHCP server side, and each DHCP client computer receives this information when the IP address is provided at its boot-up.

To obtain an IP address, the LS100 sends a corresponding DHCP request as a broadcast over the network after each reset. The reply generated by the DHCP server contains the IP address as well as the subnet mask, gateway address, DNS servers and the lease time. The LS100 immediately places this information in its non-volatile memory. If the operating time reaches the lease time, the LS100 will request the DHCP server for renewal of its lease time. If the DHCP server approves extending the lease, the LS100 can continue to work with the current IP address. Otherwise, the LS100 will start the procedure to request a new IP address to the DHCP server.

A DHCP server assigns IP addresses dynamically from an IP address pool, which is managed by the network administrator. This means DHCP client, i.e. the LS100, receives a different IP address each time it boots up. To prevent the case that users do not know the IP address of the LS100 in such environments, its IP address should be reserved on the DHCP server side. In order to reserve the IP address in the DHCP network, the administrator needs the MAC address of the LS100 found on the label sticker at the bottom of the LS 100:

```
MAC=00:01:95:04:0c:a1
```

3.2.2 DHCP Configuration

To make the LS100 work in DHCP mode, just set IP mode to DHCP as in Figure 3-2.

```
> set ip dhcp
OK
>
```

Figure 3-2. Setting DHCP mode

3.3 PPPoE

3.3.1 Overview

PPPoE (PPP over Ethernet) is a specification for connecting multiple computer users on an Ethernet local area network to a remote site through common customer premises equipment, which is the telephone company's term for a modem and similar devices. PPPoE can be used to have an office or building-full of users share ADSL, cable modem, or wireless connection to the Internet. Usually, it is used in broadband Internet access such as ADSL.

To make the LS100 work in PPPoE mode, users should have a PPPoE account and the equipments for PPPoE access such as an ADSL modem. Since the LS100 provides the PPPoE protocol, it can access the remote host on the Internet over ADSL connection. It is required to set up the user name and password of the PPPoE account.

If the IP mode is set to PPPoE, The LS100 negotiates the PPPoE connection with PPPoE server whenever it boots up. During the negotiation, it receives the information required for Internet connection such as IP address, gateway, subnet mask and DNS servers. If the connection is established, the LS100 tries to maintain the connection as long as possible. If the disconnection is detected, the LS100 will attempt to make a new PPPoE connection by requesting the new connection.

3.3.2 PPPoE Configuration

To make the LS100 work in PPPoE mode, users need to configure the PPPoE username and password for their ADSL account as in Figure 3-3.

```
> set ip pppoe pppoeuser pppoepassword
OK
>
```

Figure 3-3. Setting PPPoE mode

4. Host Mode Configuration

Host mode represents the operating session mode of the LS100. Several host modes are available for the data communication between the serial device and remote hosts. Since TCP is connection-oriented protocol, server, client, server/client modes are provided. Table 4-1 shows the brief description of the host modes. A factory default host mode is **TCP Server**.

Table 4-1. The LS100 TCP/IP session modes

Mode	Description
TCP server	Select this mode, when users want the LS100 to operate as a TCP server. The LS100 stands by until there is any TCP connection request. If TCP connection is not already established at that time, the LS100 accepts the request and the session is established. In the established state, it transmits the data through the serial port if there is any data from the remote host. Since the LS100 supports only one TCP session for the serial port, the additional TCP connection request will be rejected if already established. This mode is useful when users want to send data to the serial device at any time they want.
TCP client	Select this mode, when users want the LS100 to operate as a TCP client. When the serial device sends data or pre-defined timer is expired, the LS100 tries to establish a TCP connection to a remote server through its TCP port. If a TCP session is established between them, the LS100 will send data to the server. If there's any data from the server during the session, it will also send the data through the serial port. However, if the LS100 failed to connect to the remote server, the data from the serial port will be discarded. This is useful when the serial device initiates sending data such as data gathering application.
TCP server/client	If you are not sure which mode to choose, select this mode since it will be applied in most applications. In this mode, the LS100 operates as TCP server AND client. If the connection is not established, it will accept all incoming connection and connect to the remote host if there are any data from the serial device. Otherwise, it will send data back and forth. In summary, the LS100 will work as if it is virtually connected to the remote host.

For each host mode, required parameters for configuration is summarized in Table 4-2.

Table 4-2 Host mode configuration parameters

TCP Server	Listening TCP port
	Inactivity timeout (sec)
TCP Client	Destination IP
	Destination TCP Port
	Cyclic connection Interval
	Inactivity timeout (sec)
TCP Server/Client	Listening TCP port
	Destination IP
	Destination TCP Port
	Cyclic connection Interval
	Inactivity timeout (sec)

Basic 'set' command usage for host mode configuration is as follows:

set host hostmode par1 par2 ...

where,

hostmode: tcps=TCP server / tcpc=TCP client / tcpsc=TCP server & client

parameters:

if hostmode = TCP server (tcps),

par1 = listening TCP port,

par2 = inactivity timeout (sec)

if hostmode = TCP client (tcpc),

par1 = destination IP address,

par2 = destination TCP port,

par3 = cyclic connection interval (min),

par4 = inactivity timeout (sec)

if hostmode = TCP server & client (tcpsc),

par1 = listening TCP_port,

par2 = destination IP address,

par3 = destination TCP port,

par4 = cyclic connection interval (min),

par5 = inactivity timeout (sec)

*** set cyclic connection interval to 0 not to use cyclic connection**

*** set inactivity timeout to 0 for unlimited timeout**

For easier understanding of TCP modes, a simplified **State Transition Diagram** is often used. And to help users understand the diagram, the TCP state of the LS100 is briefly described as follows.

- Listen

It represents "a waiting for a connection request from any remote host". It is a default start-up mode when it is set as *TCP server* mode. This state is valid only in *TCP server* mode operation.

- Closed

It means "No connection state at all". If the data transfer is completed, the state is changed to this state if one of the host requests disconnection request. If it is in *TCP server* mode, the state is automatically changed to [Listen] mode. It is a default start-up mode when it is set as *TCP client* mode or *TCP server/client* mode.

-Sync-Received

In *TCP server* mode, the state will be changed from [Listen] to [Sync-Received], if any remote host sends connection request. If the LS100 accepts the request, the state will be changed into [Established]. This state is not valid in *TCP client* mode.

- Sync-Sent

If the LS100 sends a connection request to a remote host, the state is changed from [Closed] to [Sync-Sent]. This state is maintained until the remote host accepts the connection request. This state is valid only in *TCP client* mode.

- Established

It represents “an open connection”. If one of the hosts accepts a connection request from the other host, the connection is opened and state is changed into [Established].

- Data

When it is in [Established] state, data from a host will be transferred to the other one. For easier understanding of the TCP session operation, we called the state as [Data] state when actual data transfer is performed. Actually, the [Data] mode is a part of [Established] state as is described in the RFC 793 [Transmission Control Protocol]. This is a normal state for the data transfer phase of the connection.

4.1 TCP Server Mode Operations

4.1.1 Overview

The LS100 works as a TCP server, and the default TCP state is [Listen] in this mode. The LS100 supports only one TCP socket connection per one serial port. If a connection is currently established, the additional connection requests will be rejected. The remote host will be either Ethernet-Serial communication devices acting as a TCP client or a socket program acting as a TCP client running on users' PC.

1) Typical State Transition

[Listen] --> [Sync-Received] --> [Established] --> [Data] --> [Closed] --> [Listen]

At start-up, an initial TCP state is [Listen]. If there is any incoming TCP connection request, the state will be changed into [Sync-Received], then [Established], which means a session is opened. For a while, data will be transferred between the hosts. This is the [Data] state. The session will be disconnected due to the request of one of them, which is [Closed] state. And then, the state is automatically changed to its original state, [Listen].

2) Operations

Serial data transfer

When a session has been established, the LS100 reads the data from the serial port buffer till internal serial buffer is full or inter-character time interval reaches the time specified as *inter-character timeout* value. Then, it transfers the data to the IP address of the remote host. If there's no remote host connected to the LS100, all the incoming data from the serial port are discarded.

Session disconnection

The connected session will be disconnected when the remote host sends disconnection request or when no data transfer activity is found through the serial port for a certain amount of time, which is "*Inactivity timeout*".

Figure 4-1 shows the State Transition Diagram of the session operations in *TCP server mode*.

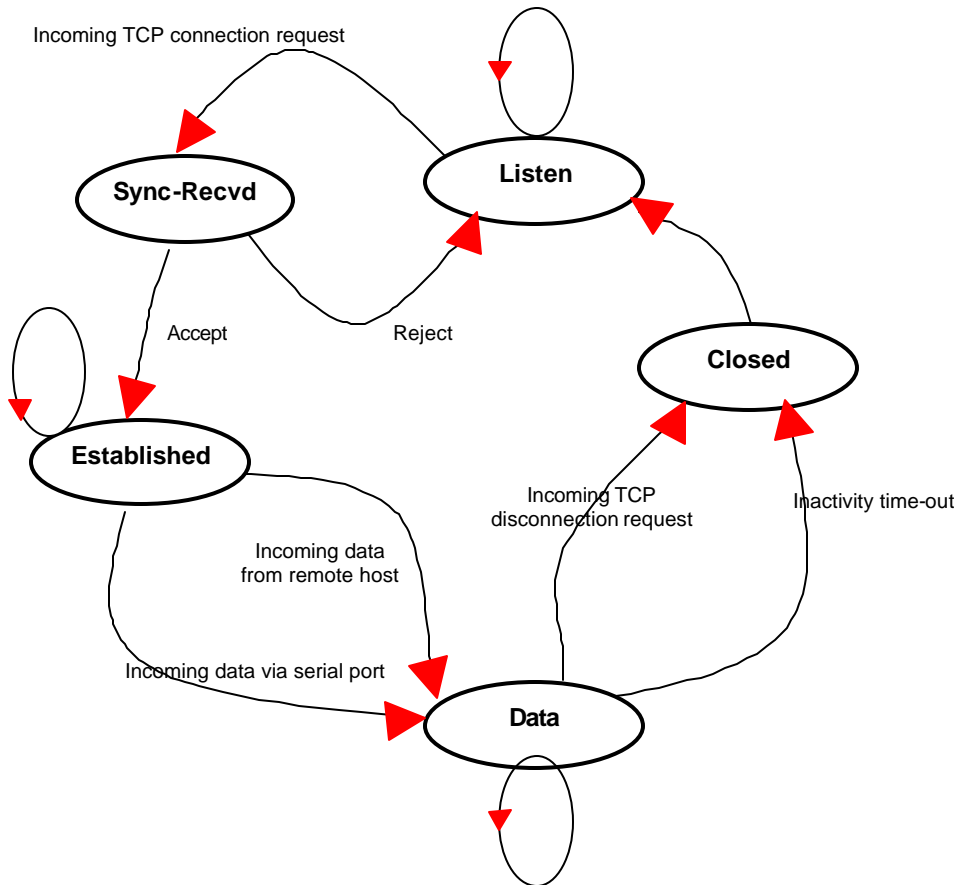

Figure 4-1. State Transition Diagram of TCP server mode

4.1.2 TCP Server Mode Configuration

To configure the LS100 to work as a TCP server, use 'set' command as follows:

```
set host tcps listening_TCP_port inactivity_timeout + <CR>
```

where,

listening_TCP_port: Listening TCP port

Inactivity_timeout: Inactivity timeout in seconds.

Listening TCP port is the TCP port number through which remote host can connect a TCP session, and, send and receive data. Incoming connection request to the ports other than *Listening TCP Port* will be rejected. The LS100 does not restrict the number to a specific range, but it is strongly recommended not to use the well-known ports for certain application (See Appendix D. *Well-known Port Numbers*). To change the port number, select menu 2 on the *TCP Server* mode configuration screen.

Inactivity timeout is set to maintain the TCP connection state as *Closed* or *Listen* in TCP host mode unless there is any data transfer between the serial device and the LS100. If there is no incoming or outgoing data through the serial port during the specified *inactivity timeout* interval, the existing TCP connection will be closed automatically.

If the value of *inactivity timeout* is set to 0, the current TCP connection is maintained unless there's no connection close request. Although *inactivity timeout* is disabled, the LS100 will check the connection status between the LS100 and the remote host by sending "keep alive" packets periodically. If the remote host does not answer the packets, it is regarded that the connection is down unintentionally. Then, the LS100 will force to close the existing TCP connection.

Note:

At least, this value should be set larger than that of *inter-character timeout*. To prevent the unintended loss of data due to the session disconnection, it is highly recommended that this value is set large enough so that the intended data transfer is completed.

Figure 4-2 shows TCP server mode setting example:

```
> set host tcps 6001 300
OK
>
```

Figure 4-2. TCP server mode setting

4.2 TCP Client Mode Operations

4.2.1 Overview

The LS100 works as a TCP client, and the default TCP state is [Closed] in this mode. The remote host will be either Ethernet-Serial communication devices acting as a TCP server or a socket program acting as a TCP server running on users' PC.

1) Typical State Transition

[Closed] --> [Sync-Sent] --> [Established] --> [Data] --> [Closed]

At start-up, an initial TCP state is [Closed]. If there is any incoming data through the serial port, the LS100 will try to connect to a user-defined remote host. Then, the state will be changed to [Sync-Sent], which means the connection request is being sent. If the remote host accepts the request, the state will be changed into [Established], which means a session has been opened. For a while, data will be transferred between the hosts. This is [Data] state. The session will be disconnected due to the request of one of them, which is its original state, [Closed].

2) Operations

Serial data transfer

Whenever the serial device sends data through the serial port of the LS100, data will be accumulated to the serial port buffer of the LS100. If the internal serial port buffer is full or inter-character time interval reaches to the time specified as *inter-character timeout* value, it tries to connect to the user-defined IP address of the remote host, if TCP session is not established yet. If the LS100 succeeds in connecting to the remote host, the data in the serial port buffer will be transferred to the host. Otherwise, all the data stored in the buffer will be cleared.

Session disconnection

The connected session will be disconnected when the remote host sends disconnection request or when no data transfer activity is found through the serial port for certain amount of time, which is "*Inactivity timeout*". All the data remained in the serial port buffer will be cleared when it is disconnected.

Connection request from remote host

All the incoming TCP connection requests will be rejected in *TCP client* mode.

Cyclic Connection

If *Cyclic Connection* function is enabled, the LS100 will make an attempt to connect to the user-defined remote host at certain interval even if there's no incoming serial data from the device. If the remote host prepares certain data, it will be transferred to the serial device via its serial port

after the connection is established. Eventually, users can monitor the serial device periodically by making the remote host send the serial command to the LS100 whenever it is connected to the remote host. This option is useful when users need to gather the device information periodically even if the serial device does not send its data periodically. Figure 4-3 shows the State Transition Diagram of the session operations in *TCP client* mode.

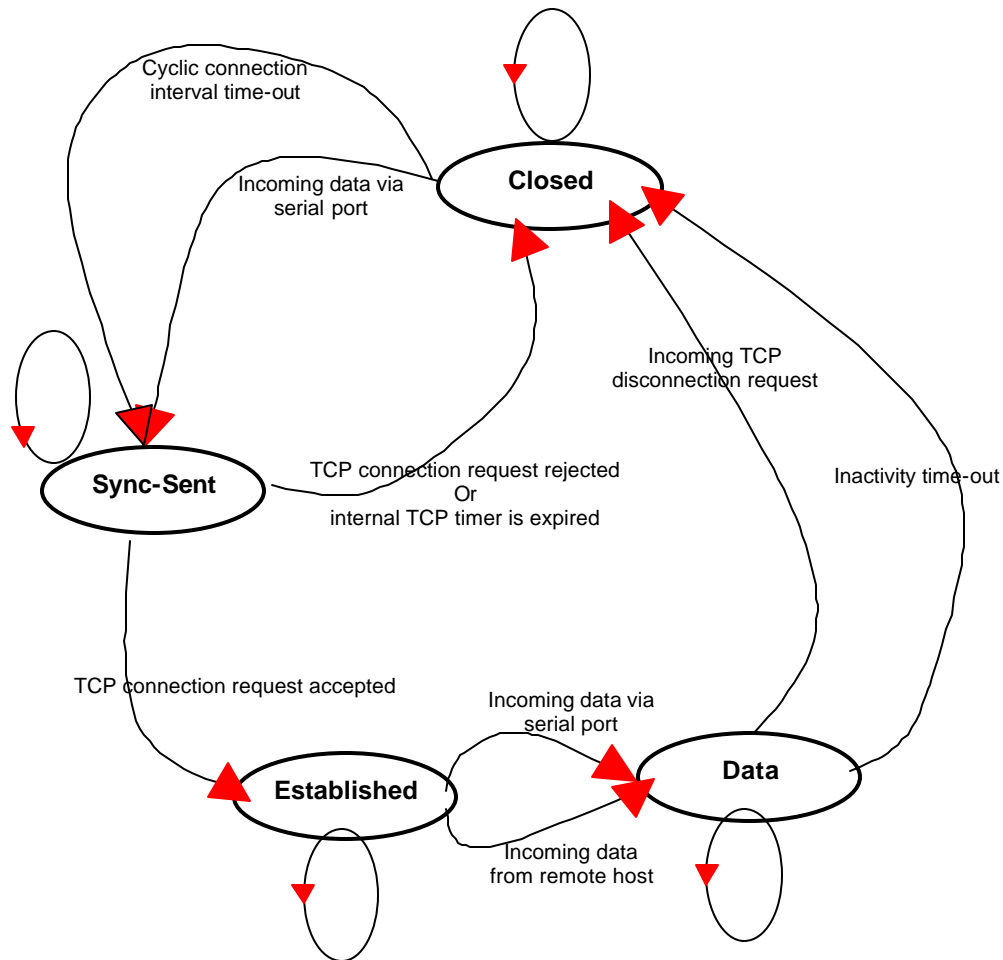

Figure 4-3. State Transition Diagram of TCP client mode

4.2.2 TCP Client Mode Configuration

To configure the LS100 to work as a TCP client, use set command as follows:

set host tpc dest_ip dest_port cyclic_connection_interval inactivity_timeout + <CR>

where,

dest_ip = destination IP address

dest_port = destination TCP port

cyclic_connection_interval = cyclic connection interval in minutes

inactivity_timeout = inactivity timeout in seconds.

Destination IP address and **destination TCP Port** are the information on the remote host to which the LS100 will try to connect in TCP client mode. The IP address (or domain name) should be specified together with the TCP port number.

Cyclic connection interval is the time interval at which the LS100 will try to connect to the remote host regardless of the existence of incoming data from the serial port. If the interval is specified with a valid value other than 0, the function is enabled. The time interval will be the specified value by the unit of minute. If the interval is entered as 0, cyclic connection feature will be disabled.

Inactivity timeout is the same as described in TCP server mode setting section.

Figure 4-4 shows TCP client mode setting example:

```
> set host tcp 192.168.1.1 6001 10 300
OK
>
```

Figure 4-4 TCP client mode setting

4.3 TCP Server/Client Mode Operations

4.3.1 Overview

The LS100 works as either TCP server or client according to the situation. This will be the typical mode for most applications, since it will transfer the data either from serial port or from TCP port. The default TCP state is [Listen] which is the same as that of *TCP server mode*.

1) Typical State Transition

[Listen] --> [Sync-Received] --> [Established] --> [Data] --> [Closed] --> [Listen]

Or

[Listen] --> [Sync-Sent] --> [Established] --> [Data] --> [Closed] --> [Listen]

The initial state is [Listen]. If there are data coming from the serial port, it will connect to the remote host as a TCP client. If there is incoming connection request from the remote host, it will accept the connection as a TCP server, and then transfer data through the serial port. Thus, users can assume that the LS100 is always connected to the specified remote host.

2) Operations

The only difference from *TCP server* mode is that the LS100 will try to connect and send serial data to the remote host even if the TCP session is not established. The difference from *TCP client* mode is that it will accept incoming connection request from remote host if the session is not established. The detailed operation principles are the same as that of *TCP server* and *TCP client* mode.

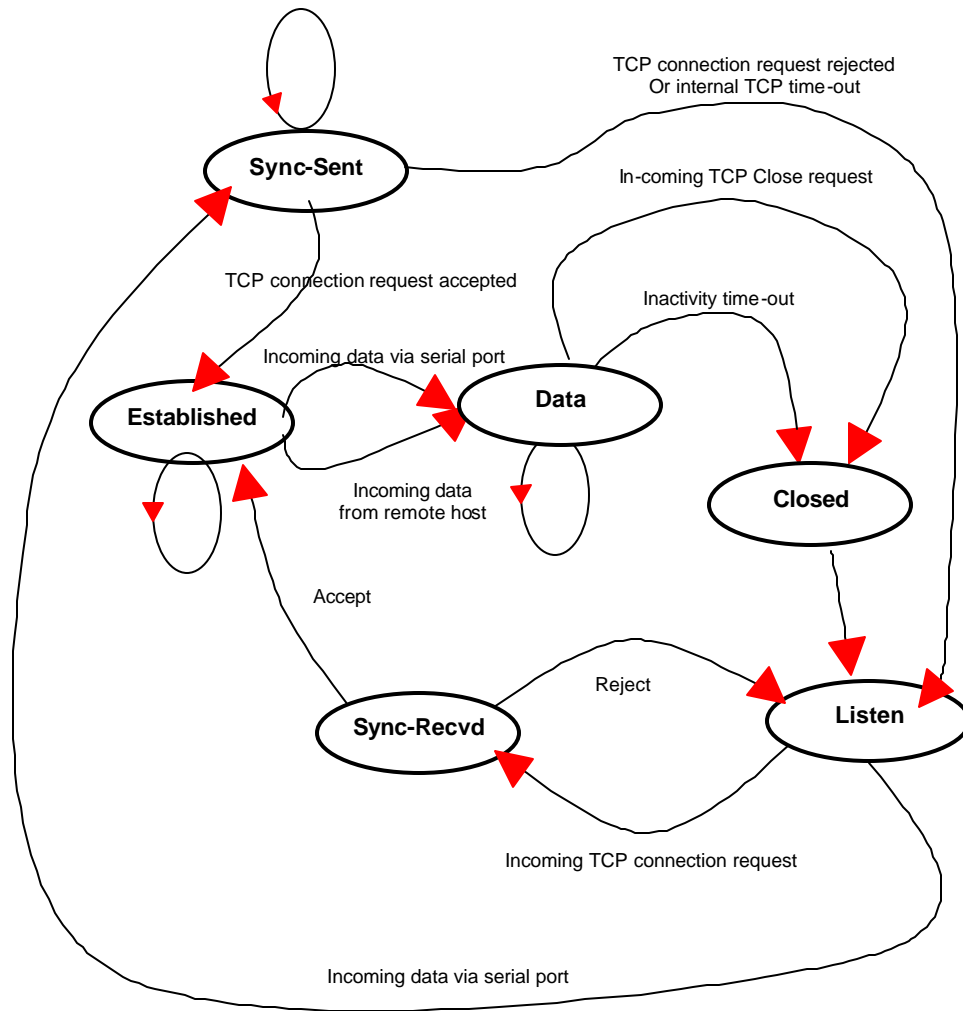

Figure 4-5. State Transition Diagram of TCP server/client mode

4.3.2 TCP Server/Client Mode Configuration

To configure the LS100 to work as a TCP server/client mode, use 'set' command as follows:

set host tcpsc listening_port dest_ip dest_port cyclic_connection_interval inactivity_timeout
where,

listening_port = listening TCP port

dest_ip = destination IP address

dest_port = destination TCP port

cyclic_connection_interval = cyclic connection interval in minutes

inactivity_timeout = inactivity timeout in seconds.

Parameter definitions for TCP server and client mode configuration are the same with TCP server mode and TCP client mode parameters.

Figure 4-6 shows TCP server/client mode setting example:

```
> set host tcpsc 6001 192.168.1.100 7001 10 300
OK
>
```

Figure 4-6 TCP server/client mode setting

5: Serial Port Configuration

To attach the serial device to the LS100 serial port, its serial port operation should match exactly to that of the serial device. Serial port configuration parameters are summarized in Table 5-1.

Table 5-1. Serial Port Configuration parameters

Parameter	Values
Baud rate	1200, 2400, 4800, 9600, 19200, 38400, 57600, or 115200
Data bits	7 bits or 8 bits
Parity	None, Even or Odd
Stop bits	1 bit or 2 bits
Flow control	None, Hardware (RTS/CTS)
DTR option	Always HIGH, Always LOW, or Show TCP connection
DSR option	None, Accept TCP connection only by HIGH, or Open/Close TCP connection
Inter-character timeout	Inter-character timeout value in milliseconds

To configure serial port parameters, use 'set' command as follows:

```
set serial baudrate data_bits parity stop_bits flow_control dtr_option dsr_option  
interchar_timeout(ms)
```

where,

baudrate: 1200, 2400, 4800, 9600, 19200, 38400, 57600, or 115200

data_bits: 7=7-bits / 8=8-bits

parity: n=none / e=even / o=odd

stop_bits: 1=1-bit / 2=2-bits

flow_control: n=none / h=hardware

dtr_option: h=always high / l=always low / s=show tcp connection

dsr_option: n=none / a=accept only by high / o=open,close TCP connection

interchar_timeout: inter-character timeout value in milliseconds

The factory default settings of **baud rate**, **data bits**, **parity** and **stop bits** are *9600*, *8 data bits*, *No parity* and *1 stop bit* respectively. Among the serial configuration, there are three serial modes the LS100 does not support. The LS100 does not support 7 data bits, No parity, 1 stop bit configuration. In this case, the LS100 will operate as 7 data bits, No parity, 2 stop bit mode. In case the LS100 is configured as 8 data bits, Even(or Odd) parity, 2 stop bits mode, the LS100 will operate as 8 data bits, Even (or Odd) parity, 1 stop bit mode.

The factory default setting of the **flow control** is *None*. Only hardware flow control using RTS/CTS is

supported by the LS100. Hardware flow control method controls data communication flow by sending signals back and forth between two connected devices.

The purpose of the DTR/DSR pin is to emulate modem signal control or to control TCP connection state by using serial port signal. The DTR is a write-only output signal, whereas the DSR is a read-only input signal in the LS100 side.

The **DTR option** can be set to one of three types: *always high*, *always low* or *show TCP connection*. If the DTR behavior is set to *show TCP connection*, the state of the DTR pin will be maintained high if the TCP connection is established.

The **DSR option** can be set to one of three types: *none*, *allow TCP connection only by high* or *open/close TCP connection*. *Allow TCP connection only by HIGH* is valid only if host mode is TCP server or equivalent. If this option is set, the incoming TCP connection request will be accepted only when the DSR signal is high state. *Open/close TCP connection* is valid only if the host mode is a TCP client or equivalent. If the DSR behavior is set to *open/close TCP connection*, the high state of the DSR pin will make the LS100 send a connection request to the specified destination host, whereas the low state close a connection.

Inter-character timeout defines the interval that the LS100 fetches the overall serial data from its internal buffer. If there is incoming data through the serial port, the LS100 stores data into the internal buffer. The LS100 transfers data stored in the buffer via TCP/IP, only if the internal buffer is full or if the inter-character time interval reaches to the time specified as *inter-character timeout*.

Optimal inter-character timeout would be different according to your application but at least it must be larger than one character interval within specified baud rate. For example, assume that the serial port is set to 1200 bps, 8 Data bits, 1 stop bit, and no parity. In this case, the total number of bits to send a character is 10 bits and the time required to transfer one character is

$$10 \text{ (bits)} / 1200 \text{ (bits/s)} * 1000 \text{ (ms/s)} = 8.3 \text{ ms.}$$

Therefore, you have to set *inter-character timeout* to be larger than 8.3 ms. The *inter-character timeout* is specified in milliseconds and must be larger than 10 ms.

If users want to send the series of characters into a packet, serial device attached to the LS100 should send characters without time delay larger than *inter-character timeout* between characters and the total length of data must be smaller than or equal to the LS100 internal buffer size. The serial communication buffer size of LS100 is 1400 bytes.

Figure 5-1 shows serial port configuration example of 9600 bps, 7 data bits, even parity, 2 stop bits, hardware flow control, DTR shows TCP connection, No DSR behavior and inter-character time out of 10 ms:

```
> set serial 9600 7 e 2 h s n 10
```

```
OK  
>
```

Figure 5-1 Serial port configuration

6: System Administration

Users can configure administrator username, password and device name using set command as follows:

set admin username password devicename

username: login username

password: login password

devicename: device name

Figure 7-1 shows administrative parameters configuration example:

```
> set admin adminuser adminpassword LS100_test1
OK
>
```

Figure 7-1 Administration parameters configuration

Appendix A: Connections

A.1 Ethernet Pin outs

The LS100 uses standard Ethernet connector, which is a shielded connector compliant with AT&T258 specifications. Table A-1 shows the pin assignment and the wire color.

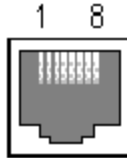

Figure A-1 Pin layout of the RJ45 connector

Table A-1. Pin assignment of the RJ45 connector

Pin	Description	Color
1	Tx+	White with orange
2	Tx-	Orange
3	Rx+	White with green
4	NC	Blue
5	NC	White with blue
6	Rx-	Green
7	NC	White with brown
8	NC	Brown

A.2 Serial Port Pin Outs

The pin assignment of the LS100 DB9 connector is summarized in Table A-2. Each pin has a function according to the serial communication type configuration.

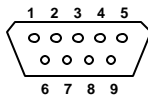

Figure A-2 Pin layout of the DB-9 connector

Table A-2. Pin assignment of the DB-9 connector

Pin	RS232
1	-
2	Rx
3	Tx
4	DTR
5	GND
6	DSR
7	RTS
8	CTS
9	-

A.3 Ethernet Wiring Diagram

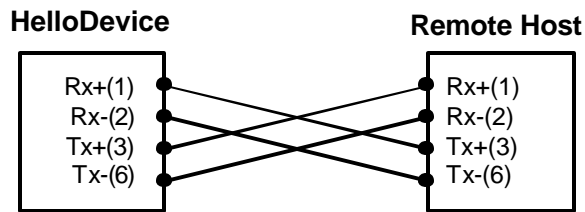

Figure A-3 Ethernet direct connection using crossover ethernet cable

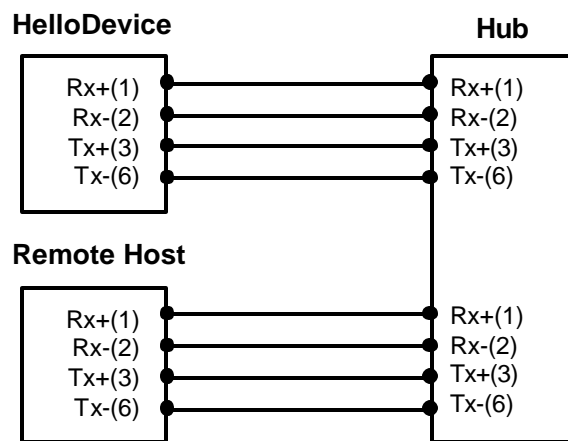

Figure A-4 Ethernet connection using straight through ethernet cable

A.4 Serial Wiring Diagram

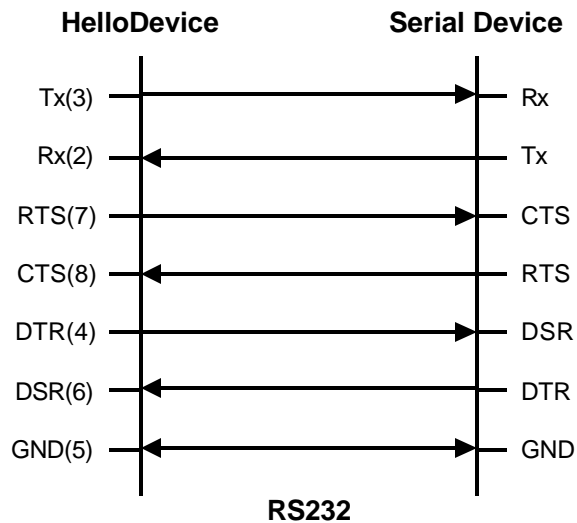

Figure A-5 RS232 wiring diagram

Appendix B: Well-known Port Numbers

The port numbers are divided into three ranges: the Well Known Ports, the Registered Ports, and the Dynamic and/or Private Ports. The Well Known Ports are those from 0 through 1023. The Registered Ports are those from 1024 through 49151. The Dynamic and/or Private Ports are those from 49152 through 65535.

The Well Known Ports are assigned by the IANA, and on most systems, can only be used by system processes or by programs executed by privileged users. Table B-1 shows famous port numbers among the well-known port numbers. For more details, please visit IANA website:

<http://www.iana.org/assignments/port-numbers>

Table B-1 Well-known port numbers

Port number	Protocol	TCP/UDP
21	FTP (File Transfer Protocol)	TCP
22	SSH (Secure SHell)	TCP
23	Telnet	TCP
25	SMTP (Simple Mail Transfer Protocol)	TCP
37	Time	TCP, UDP
39	RLP (Resource Location Protocol)	UDP
49	TACACS, TACACS+	UDP
53	DNS	UDP
67	BOOTP server	UDP
68	BOOTP client	UDP
69	TFTP	UDP
70	Gopher	TCP
79	Finger	TCP
80	HTTP	TCP
110	POP3	TCP
119	NNTP (Network News Transfer Protocol)	TCP
161/162	SNMP	UDP

Appendix C: Troubleshooting

C.1 Power/LED Status Troubleshooting

Problem	Cause	Action
Power LED does not light up	Power cable is not connected	Check power connection
Link LED does not light up	Ethernet cable is not connected	Check Ethernet cable connection
	Invalid Ethernet cable is used	There are two types of Ethernet cables: Straightthrough cable and crossover cable. If you are using an Ethernet hub, use straight-through cable. If direct connection between the LS100 and remote host is used, use crossover cable instead.
ACT LED does not blink	Invalid IP configuration	Check IP configuration parameters

C.2 Serial Console Troubleshooting

Problem	Cause	Action
Serial console is not connected	Invalid serial cable	Be sure to use a serial console cable (null-modem cable) for serial console
	Invalid serial port configuration of terminal emulation program	Check serial port configuration of terminal emulation program: 9600 bps, 8 Data bits, No parity, 1 stop bit, Hardware flow control
	Invalid Console/Data switch position	Be sure that Console/Data switch position is Console side.
Serial console is halted for few seconds periodically	IP mode is DHCP, but IP is not assigned	If IP mode is set to DHCP but IP is not actually assigned because of DHCP server failure, serial console is halted for few seconds at every 20 seconds. Change IP mode to the static IP mode
Cannot login to console	Invalid username and/or password	Use valid username and password. If username and/or password are lost, perform factory default reset using factory reset switch. Factory default value of username and password are both <i>admin</i>

C.3 Remote Console Troubleshooting

Problem	Cause	Action
Cannot connect to the LS100 using telnet	The LS100 is not assigned valid IP address	Use serial console to assign valid IP address to the LS100
	Someone is using serial console	Exit serial console and retry telnet connection

Cannot login to console	Invalid username and/or password	Use valid username and password. If username and/or password are lost, perform factory default reset using factory reset switch. Factory default value of username and password are both <i>admin</i>
-------------------------	----------------------------------	---

C.4 IP Address Troubleshooting

Problem	Cause	Action
Cannot find IP address of the LS100		Use serial console to find IP address
		Use HelloDeviceManager program to probe the LS100 on the network
HelloDeviceManager cannot probe the LS100	The LS100 is not assigned valid IP address	Use serial console to assign valid IP address to the LS100
	HelloDeviceManager and the LS100 are not on the same subnet	Run HelloDeviceManager on the PC that is on the same subnet with the LS100

C.5 DHCP Troubleshooting

Problem	Cause	Action
Cannot lease IP address	DHCP server is not working	Check if DHCP server is working correctly
IP address of the LS100 is changed	DHCP server does not extend lease time	Check if DHCP server is working correctly

C.6 TCP Server Mode Operation Troubleshooting

Problem	Cause	Action
Cannot connect to the LS100	IP configuration of remote host is invalid	Check if IP configuration of the remote host is valid
	Host mode of the LS100 serial port is not TCP server	Change the host mode of the LS100 serial port to TCP server or TCP server/client
	IP address of the LS100 or TCP port number is wrong	Specify valid IP address and TCP port number of the LS100
	DSR option is set but DSR input is not high	Disable DSR option or make DSR input of the LS100 high
	TCP connection with the other host is established already	Close established TCP connection or connect later

C.7 Serial Communication Troubleshooting

Problem	Cause	Action
Serial data are not transferred by TCP/IP immediately	Too large inter-character timeout	Set inter-character timeout with smaller value
Cannot communicate with the LS100	Invalid serial port configuration	Check if serial port configuration of the LS100 are the same with that of the serial device
Invalid data transferred	Invalid serial port configuration	Check if serial port configuration is correct.